

A15-2212

Technical Specification

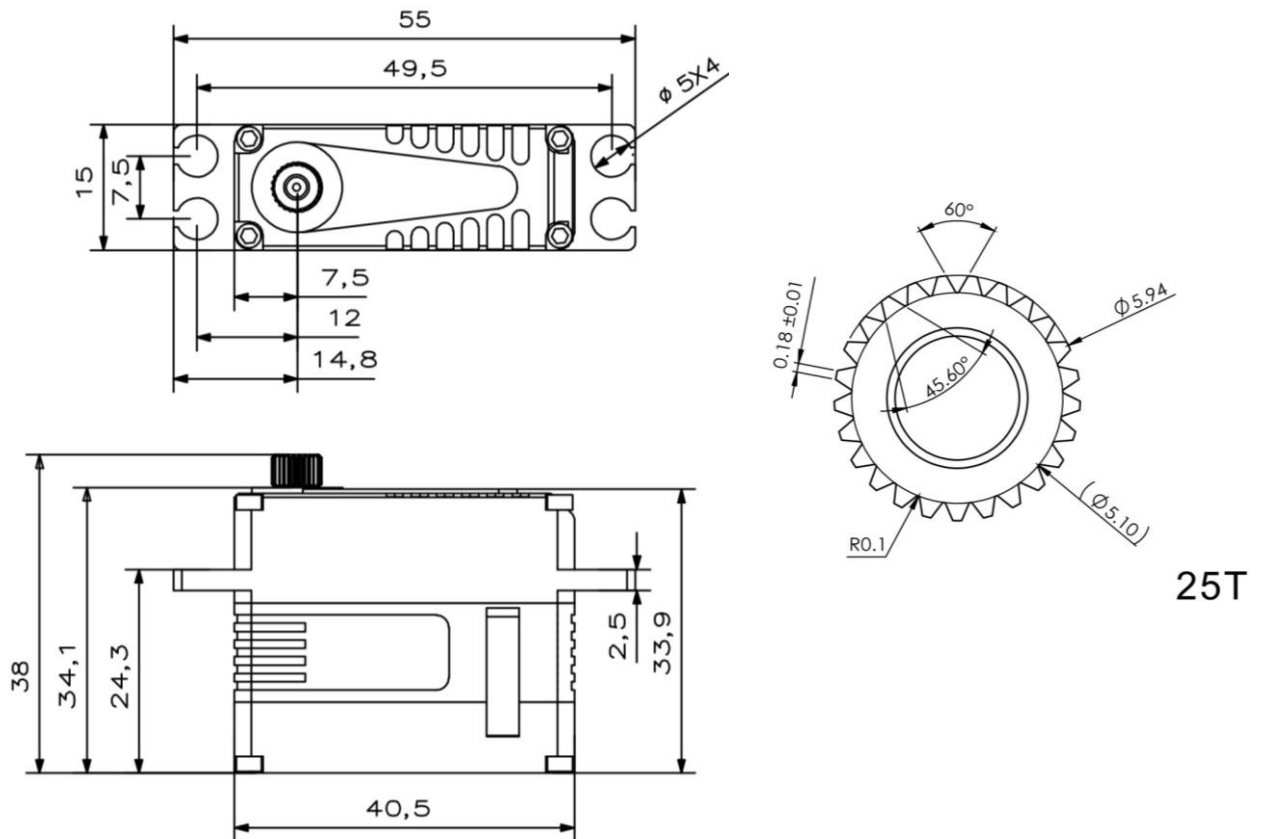
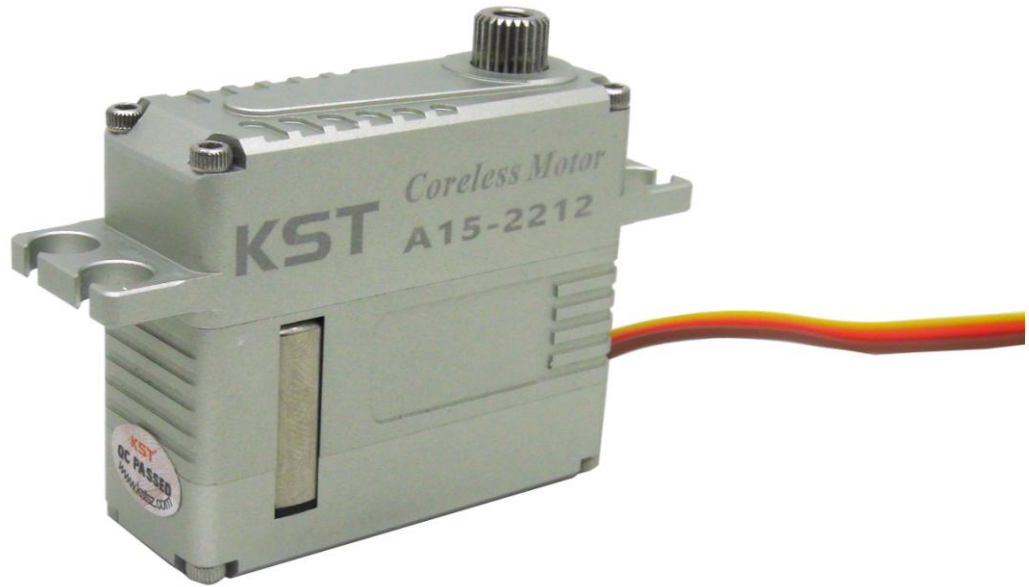

Operating Data

	A15-2212
Operation Voltage(rated)	DC7.4V
Operation Voltage Range	DC6.0V-8.4V
Torque	18Kg.cm@6.0V
	22Kg.cm@7.4V
	25Kg.cm@8.4V
Speed	0.15sec/60 °@6.0V
	0.12sec /60 °@7.4V
	0.11sec /60 °@8.4V
Travel Angle	± 50° when 1000-2000us
Operating Temperature Range	-10°C·····+55°C

Performance

A15-2212 @ 7.4V

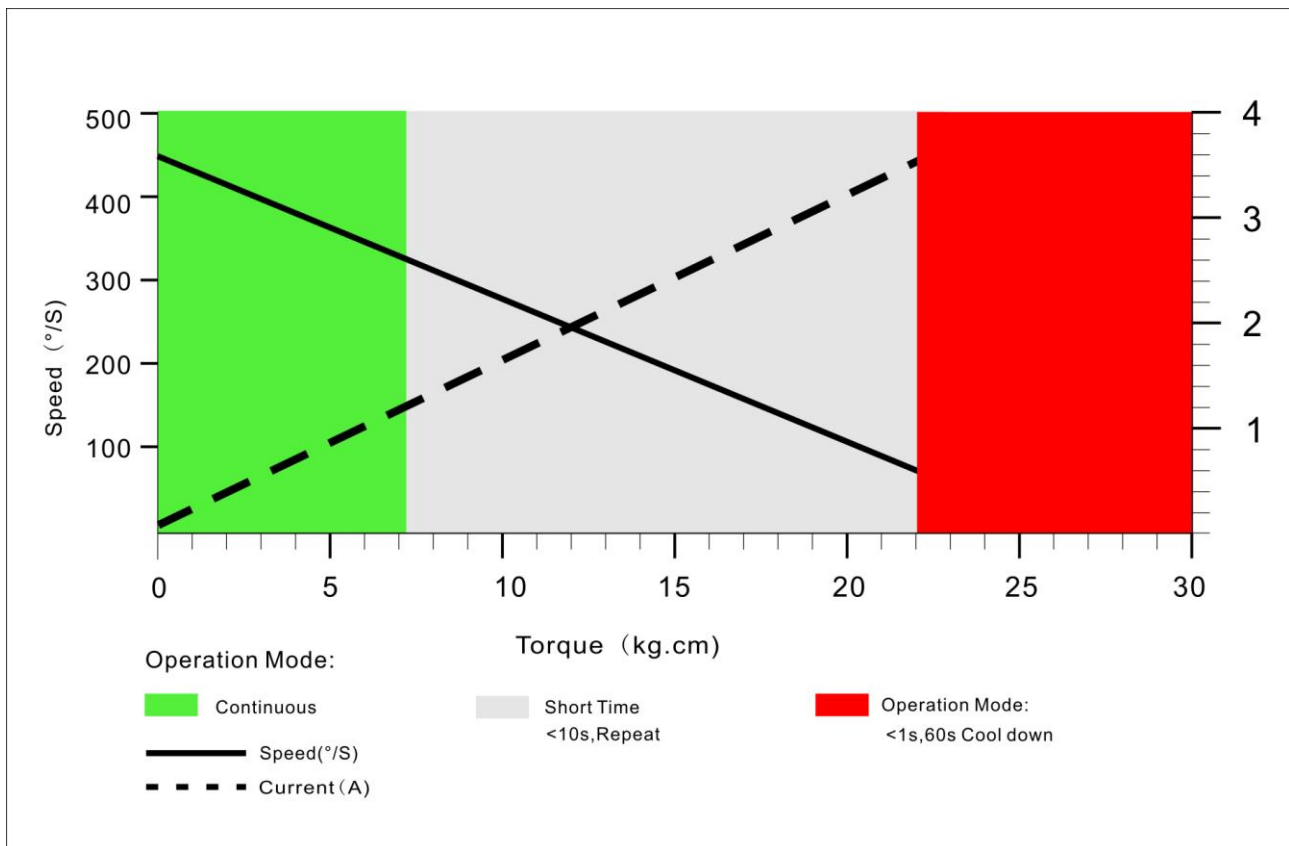

PWM Command Signal

PWM	A15-2212
Signal Voltage	TTL-Level: HIGH:min.3.3V,max.5.0V TTL-Level: Low:min.0.0V,max.1.5V
Pulse Lengths	900-2100us
Pulse Lengths for Position -50° /center/+50°	1000us/1500us/2000us
Resolution	<2us

Materials and protective features

Case Material	Aluminum Alloy
Motor Type	Coreless
Gear Set Material	Phosphor Bronze+Hardened Steel
Position Sensor	Potentionmeter
Position Feedback	Optional
Shielded Connecting Cable	22AWG

Dimensions

Case Dimensions	40.5*15*34mm
Weight	52g